

Ficha Técnica



CREE
LEDs
SMD2835

CODIGO	POTENCIA	LM	TENSION
5620001WW	200w	26000lm	170-260v

ESPECIFICACIONES TÉCNICAS

Ángulo de Apertura	120°
Temperatura de Color	3000k
IRC	>80
LED Chip	SMD 2835
Protecciones Driver	OVP/SCP/OPP/OTP
Temperatura de Trabajo	-20°/50°
Material	Aluminio + Cristal
Acabado	Negro
Dimensiones	375x375x88mm
Certificados	CE&Rohs

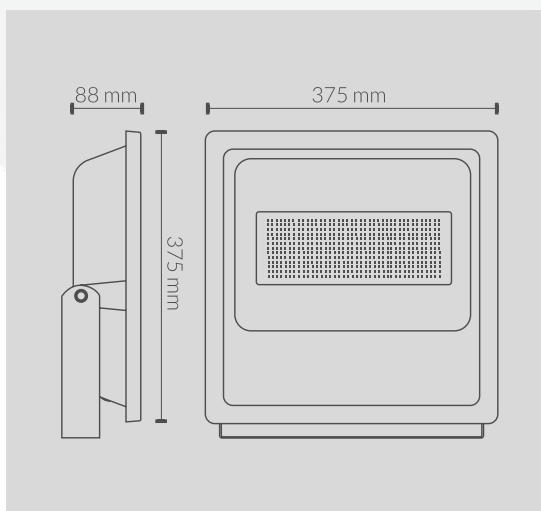

PROTECCIONES DEL DRIVER

PROTEÇÕES DO DRIVER

OVP	Protección contra sobretensión <i>Proteção contra sobretensão</i>
SCP	Protección contra cortocircuitos <i>Proteção contra curto-circuito</i>
OPP	Protección de sobrecarga <i>Proteção de sobrecarga</i>
OTP	Protección contra sobrecalentamiento <i>Proteção contra superaquecimento</i>